

motorola

moto g  
STYLUS

User Guide

# Contents

## Hot topics

### Get Started

- [First look](#)
- [Insert the SIM and microSD cards](#)
- [Charge up](#)
- [Power on](#)
- [Sign in](#)
- [Connect to Wi-Fi](#)
- [Navigate your phone](#)
- [Improve battery life](#)
- [Water repellent](#)

### Learn the basics

- [Home screen](#)
- [Help & more](#)
- [Search](#)
- [Notifications](#)
- [Status icons](#)
- [Volume](#)
- [Do not disturb](#)
- [Lock screen](#)
- [Quick settings](#)
- [Speak](#)
- [Stylus shortcuts](#)
- [Direct Share](#)
- [Picture-in-Picture](#)

### Customize your phone

- [Redecorate your home screen](#)
- [Choose apps & widgets](#)
- [Customize sounds & appearance](#)
- [Discover Moto](#)
- [Digital wellbeing and parental controls](#)

### Apps

- [Phone](#)
- [Messages](#)
- [Chrome™](#)
- [Camera](#)
- [Photos](#)
- [Gmail](#)
- [Duo](#)
- [Moto](#)
- [Moto Audio](#)

- [Moto Note](#)
- [Calendar](#)
- [More apps](#)

### Connect, share & sync

- [Connect with Wi-Fi](#)
- [Connect with Bluetooth wireless](#)
- [Share files with your computer](#)
- [Share your data connection](#)
- [Print](#)
- [Sync to the cloud](#)
- [Cast your screen to a TV](#)
- [Use a memory card](#)
- [Airplane mode](#)
- [Mobile network](#)

### Protect your phone

- [Screen lock](#)
- [Your privacy](#)
- [Screen pinning](#)
- [Backup & restore](#)
- [App safety](#)
- [Data usage](#)

### Troubleshoot your phone

- [Restart or remove an app](#)
- [Restart your phone](#)
- [Check for software update](#)
- [Reset](#)
- [Stolen phone](#)

### Accessibility

- [Create a shortcut](#)
- [Make your phone speak](#)
- [Speak to your phone](#)
- [Change your phone's display](#)
- [Change your phone's sounds](#)
- [Hearing aids \(U.S. only\)](#)



### Get more help

- [Where is my legal, safety, & regulatory information?](#)
- [Service & repairs](#)
- [Copyright & trademarks](#)

# Hot topics

Explore what your phone can do.

Topic	Location
Find and use quick settings.	<a href="#">Quick settings</a>
Choose new wallpaper, set ringtones, and add widgets.	<a href="#">Customize your phone</a>
Experience crisp, clear photos, movies, and videos.	<a href="#">Camera</a>
Set special features to match the way you use your phone.	<a href="#">Moto</a>
Browse, shop, and download apps.	<a href="#">Apps</a>
Keep your info safe. Set up your password and more.	<a href="#">Protect your phone</a>
Ask questions, get answers.	<a href="#">Speak</a>
Share your Internet connection.	<a href="#">Wi-Fi hotspot</a>

**Tip:** View all of these topics on your phone, swipe up  from the home screen and tap  **Settings** > **Help**. For FAQs and other phone support, visit [www.motorola.com/support](http://www.motorola.com/support).

## SAR

This product meets the applicable national or international RF exposure guidance (SAR guideline) when used normally against your head or, when worn or carried, at a distance of 5 mm from the body. The SAR guideline includes a considerable safety margin designed to assure the safety of all persons, regardless of age and health.

**Caution:** Before using your phone, please read the legal information. Swipe up  >  **Settings** > **About phone** > **Legal information**.

# Get Started

## First look

Let's get started. We'll guide you through startup and tell you a bit about your phone's features.

**Note:** Certain apps and features may not be available in all countries.

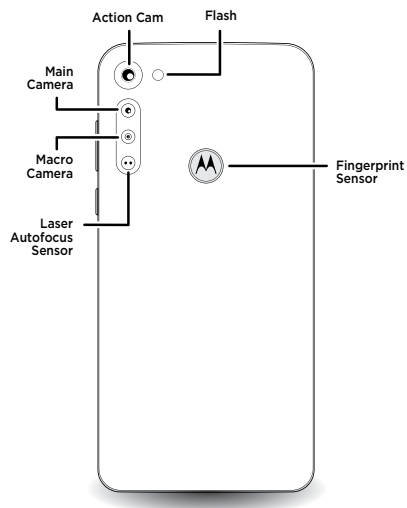
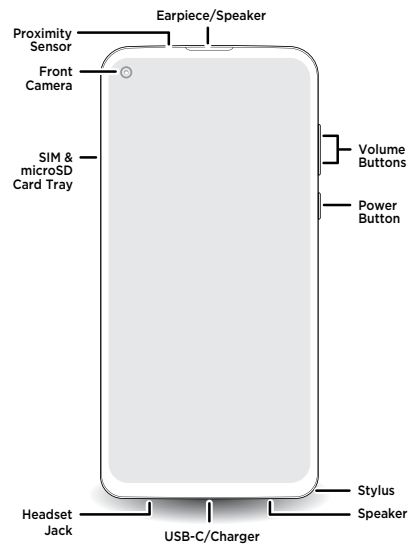

## Power button

Your Power button helps in a few ways.

- » **Power on/off:** Press and hold the Power button, then tap **Power off**. When your phone is off, press and hold the Power button to turn it on.
- » **Sleep/Wake up:** To conserve battery power and prevent accidental touches, put the touchscreen to sleep by pressing the Power button. Press it again to wake it up.
- » **Restart:** To restart your phone, press and hold the Power button, then tap **Restart**.

**Tip:** To add security to your phone, see [Protect your phone](#).

## Volume buttons

To turn volume up or down:

- » **Music/video volume:** Press the buttons when your phone is not ringing, or during a song or video, to adjust media volume.
- » **Ringer volume:** Press a volume button, then tap  and slide the Ring volume bar. Press a volume button when your phone is ringing to silence a call.
- » **Earpiece volume:** Press the buttons during a call.

**Tip:** For more on volume control, see [Volume](#).

## Remove the stylus

Your phone comes with the stylus that you can use to navigate your phone, take notes, edit screenshots, and more.

To remove the stylus, pull the end from the bottom of the phone, then slide it out.

**Tip:** For more, see [Stylus shortcuts](#).

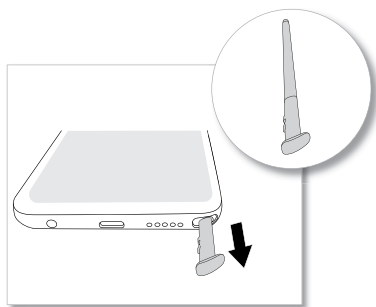

## Insert the SIM and microSD cards

To activate phone service, you might need to insert a SIM card, or this may have been done for you. You can also add a microSD card, which is optional and sold separately.

### Put in the cards

**Caution:** Make sure you use the correct size SIM card and don't cut the SIM card.

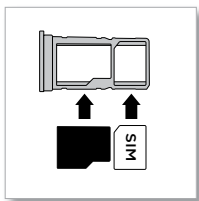
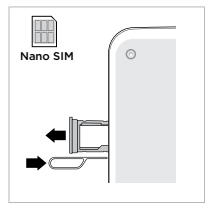

## Charge up

Use a Motorola charger to charge up your phone.

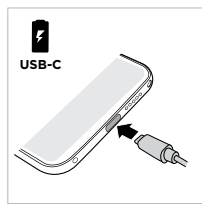

## Power on

Press and hold the Power button, then follow the prompts to get started.

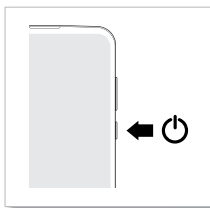

## Sign in

If you use Gmail™, you already have a Google™ account—if not, you can create an account during setup. Signing into your Google account lets you access, sync, and backup your stuff. You can see your Google apps, contacts, calendar, photos, and more.

### Tips

- » To add, edit, or delete accounts, swipe up  >  **Settings** > **Accounts**.
- » To set up email accounts, see [Gmail](#).

» For help with your Google account, visit [www.google.com/accounts](http://www.google.com/accounts).

## Connect to Wi-Fi





For faster Internet access and to conserve mobile data use, swipe the status bar down. Touch and hold  to choose a Wi-Fi network. For full instructions, see [Connect with Wi-Fi](#).

**Note:** This phone supports apps and services that may use a lot of data, so make sure your data plan meets your needs. Contact your service provider for details.

## Navigate your phone

### Explore by touch

Use Find your way around:

- » **Tap:** Choose an icon or option.
- » **Touch and hold:** See more options.
- » **Drag:** Move items on the home screen.
- » **Swipe:** Scroll through lists or between screens.
- » **Pinch or double-tap:** Zoom in and out on websites, photos, and maps.
- » **Twist:** Twist a map with two fingers to rotate it, and pull two fingers down to tilt it.
- » **Split screen:** Swipe up from the bottom of the screen and hold, then tap the icon at the top of the screen and tap  **Split screen**. Not all apps will work in split screen. To close the split screen, drag the dividing line to the bottom of the screen.
- » **Menus:** When you see , , or  you can tap it to open options for the current screen.
- » **Close Keyboard:** To close a keyboard, tap .

## System navigation

Navigate using either gestures or buttons on the screen.



### Navigation bar

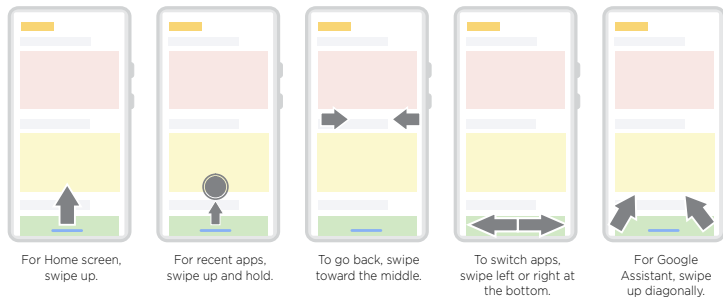

**Find it:** Swipe up  >  **Settings** > **System** > **Gestures** > **System navigation** > **Gesture navigation**





- » **Go to the home screen:** Swipe up from the bottom of the screen.
- » **See recent apps:** Swipe up from the bottom of the screen and hold. Tap an app to reopen it. Tap the app icon to see app info or split the screen.
- » **Go back a screen:** Swipe toward the middle of the screen from the left or right edge.
- » **Switch between apps:** Swipe left or right across the bottom of the screen.
- » **Launch the Google Assistant:** Swipe up diagonally from the bottom corner of the screen to launch the Google Assistant. Learn more about [The Google Assistant™](#).

### Navigation buttons

**Find it:** Swipe up  >  **Settings** > **System** > **Gestures** > **System navigation** > **3-button navigation**

- » **Back:** Tap Back  to go to the previous screen.
- » **Home:** Tap Home  to return to the home screen.



- » **Recents:** Tap Recents  to see your recent apps (or browser tabs), and tap an app to reopen it. Double tap to quickly switch between your recent apps. To remove an app from the recent list, swipe it up. To scroll the list, swipe right or left.
- » **Google Assistant:** Touch and hold Home  to launch the Google Assistant. Learn more about [The Google Assistant™](#).

## Improve battery life

Your phone processes tons of information. Depending on what apps are in use, your phone may use a lot of power.

**Note:** For the best charging experience, use a Motorola charger. Use of other chargers is not recommended.

When your phone is stationary, not charging, or not in use for a period of time, unnecessary background processes are shut down to optimize battery life.



- » To see what's using up battery power, swipe up  >  **Settings** > **Battery** > **USAGE DETAILS**.

- » To help improve battery life, swipe up  >  **Settings** > **Battery** > **Battery Saver**, and turn it on. When on, your phone's display changes to Dark theme.

**Tip:** To quickly open **Settings**, swipe down on the status bar and tap .

## Battery Tips

To save even more battery life between charges, you could reduce:

- » Widgets that stream information to your home screen, like news or weather.
- » Unused accounts: Swipe up  >  **Settings** > **Accounts**.
- » Recording or streaming videos or music.

## Water repellent

Mobile devices marketed as water repellent are not waterproof. Avoid prolonged exposure to water, and do not submerge in water. In the event your device is exposed to water, dry your device and ports thoroughly with a soft, clean cloth. Water damage is not covered by your warranty.

Tips to prevent damage to your phone:

- » Dry your phone and ports thoroughly with a soft, clean cloth.

- » Don't try to charge your phone when it's wet.
- » Do not expose your phone to salt water or other liquids.
- » Do not expose your phone to water at high pressure.
- » Do not drop or puncture your device, as this could damage the water repellent features.

# Learn the basics

## Home screen

The home screen is what you see when you turn on your phone. From here you can explore apps and more.

**Note:** Software updates may change the look of your home screen.

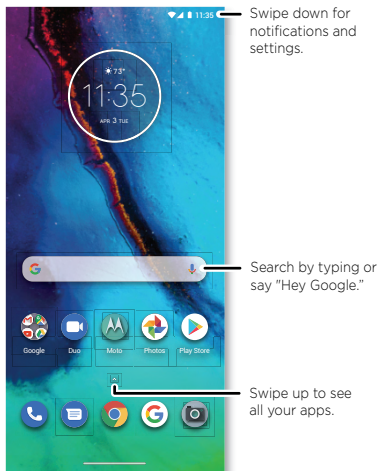

## Tips

- » **Open app list:** Swipe up  to see all your apps.
- » **Return home:** To return to the home screen from any location, swipe up from the navigation bar.
- » **Pages:** To add a page, drag an app to the right side of the screen until you see a new page. You can add multiple pages. To see other pages of shortcuts and widgets (if

available), swipe the home screen left.

- » **Settings:** To quickly open common settings, swipe the status bar down. To open more settings, swipe the status bar down again and tap .
- » **Customization:** To personalize your home screen, see [Customize your phone](#).

## Help & more

Learn even more about your phone and get support.

**Find it:** Swipe up  >  **Settings** > **Help**

**Tip:** Some apps have their own help that's specific to their features. Just tap the menu inside the app for details.

## Search

On the home screen, tap the Google Search box for a text search or tap  to search by voice.

When you type, suggestions appear below the search field:

- » To search for a suggestion, tap it.
- » To search for text in the search field, tap  on the keyboard.

**Tip:** To close the keyboard, tap .

**Note:** For voice search, see [Speak](#).

## Notifications

At the top of the screen, icons on the left notify you about new messages or events. If you don't know what an icon means, swipe the status bar down for details.

**Tip:** Getting too many notifications? Touch and hold a notification to see which app is sending them to you. Then you can turn them off.



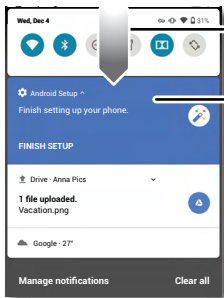

Swipe down to see your notifications.

Tap a notification to open it, or choose an option, such as **REPLY**.

**Tip:** Swipe left or right to remove a notification. Some notifications show more options when you slide them halfway.

**Tip:** To quickly change common settings, swipe the status bar down. For more, see [Quick settings](#).

## Smart reply

See suggestions based on notification content. For example, a text with an address may show Google Maps as an option.

To turn off Smart reply, tap **Messages** > Menu **:** > **Settings** > **Suggestions in chat** > **Smart Reply**.

## App notifications

You may see a notification dot on an app. This app notification, or badge, tells you the app has an update or an announcement, such as a new email or a missed call. Touch and hold the app for more information, options, or app shortcuts.



## Wireless Emergency Alerts (U.S. & some countries)

Wireless Emergency Alerts, also known as CMAS or PLAN, is a U.S. national emergency alert system. Emergency alerts can pop up to tell you about a national or local crisis. After you close an alert, you can reopen it by swiping up **^** > **Settings** > **Apps & notifications** > **Advanced** > **Wireless**



## emergency alerts.

**Tip:** Emergency alerts have a special sound and vibration that is two seconds long, followed by one second, then another one second.

To choose which types of alerts you receive, swipe up **^** > **Settings** > **Apps & notifications** > **Advanced** > **Wireless emergency alerts**. The U.S. and local governments send these alerts through your service provider. So you will always receive alerts for the area where you are, and you won't receive alerts if you're outside of the U.S.

For more, visit [www.ctia.org](http://www.ctia.org) and search "wireless emergency alerts."

## Status icons

Icons at the top right of the screen tell you about phone status:

Status Icons	
Network strength	Alarm set
Wi-Fi in range/connected	Data Saver on
Bluetooth on/connected	Battery Saver on
Airplane mode	Battery charging/full
Do not disturb	

## Volume

Press the side volume buttons up or down to select a ringer volume and see other controls.

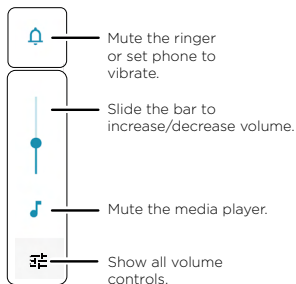

## Do not disturb

To turn off some or all sounds, swipe the status bar down, and touch and hold **Do not disturb**. Select an option:

- » **See all exceptions:** Select whether to hear alarms, media, or touch sounds.
- » **Restrict notifications:** Set if you'd like to see notifications when Do not disturb mode is on.
- » **Default duration:** Set duration Do not disturb mode is on.
- » **Schedules:** Turn on Do not disturb at specific times during the day or night, or sync with your calendar.

**Tip:** Create an exception for repeat callers that allows a call to sound from the same person within a 15 minute period, tap **Calls > Allow repeat callers**.

## Lock screen

Your touchscreen is on when you need it and off when you don't.

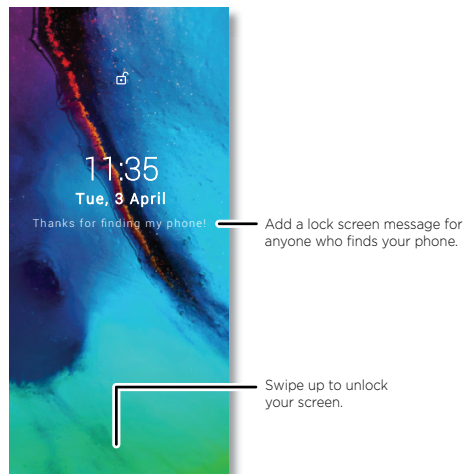

- » **Screen off and on:** Press the Power button to turn the screen off and on.
- » **Screen lock:** To unlock the screen, drag up from the bottom. To apply security to the lock screen (recommended), see [Screen lock](#).
- » **Notifications:** Double tap a notification in the lock screen to open it.  
**Tip:** To prevent notifications from appearing in the lock screen, swipe up > > **Settings > Apps & notifications > Notifications > Notifications on lockscreen > Don't show notifications**.
- » **Lock screen message:** To add a message to your lock screen, such as your name in case your phone gets lost, swipe up > > **Settings > Display > Advanced > Lock screen display > Lock screen message**.

» **Screen timeout:** To change your timeout (screen locks automatically), swipe up  >

 **Settings** > **Display** > **Advanced** > **Screen timeout.**

## Quick settings

For quick access to **Wi-Fi**, **Bluetooth**, **Airplane mode**, brightness, and other settings, swipe the status bar or lock screen down. Swipe down again for more settings. Tap an icon to toggle it on or off. Touch and hold an icon to see more options. For even more settings, tap .

Tap  to rearrange your settings and add or remove settings.

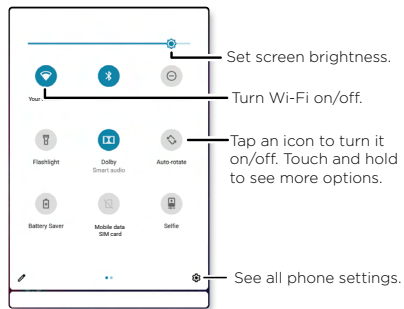

## Speak

### Google Voice™

Use Google voice commands to tell your phone what you want.

» **Use voice to make a call:** Tap  on the home screen. Then say “Call” and then a contact name or number. Or, say “Send text.”

**Tip:** If a contact has more than one number, you can say which number to call (for example, “Call Joe Black Mobile”).

» **Search by voice:** Tap  on the home screen to search by voice.

**Note:** To wake up your phone by saying “Hey Google,” see [The Google Assistant™](#).

## Voice to text

On a keyboard, tap , then speak your message or search text. You can also speak punctuation.

## The Google Assistant™

**Note:** This feature may not be available in all languages.

To open the Google Assistant, swipe up from the bottom corner of the screen, then speak or type a command.

You can also say “Hey Google” or “Ok Google” to start the Google Assistant. To turn this feature on, swipe up  >  **Settings** > **Google** > **Account services** > **Search, Assistant & Voice** > **Voice** > **Voice Match.**

**Tip:** For more on the Google Assistant, visit <https://support.google.com/assistant>.



## Stylus shortcuts

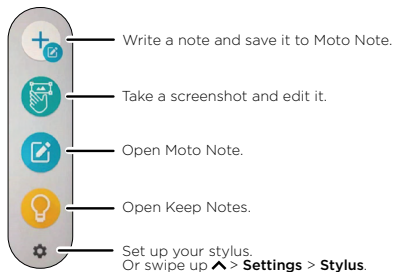

When you remove the stylus, the following stylus shortcuts appear. If you don't select a shortcut, the stylus shortcuts minimize. Click  to expand again.







» **Take a note:** Tap  to start writing or drawing in Moto Note.



» **Edit a screenshot:** Tap  to write or draw on a screenshot. For details, see [Capture your screen](#).

» **Use Moto Note:** Tap  to create, edit, and share notes in [Moto Note](#). You can also swipe up  from the home screen to find  **Moto Note**.

» **Use Keep Notes:** Tap  to create, edit, and share notes in Keep Notes. You can also swipe up  from the home screen to find  **Keep Notes**. For details, visit <https://support.google.com/keep/>.

» **Change stylus shortcuts:** To add, delete, or change the order of the shortcuts, swipe up  >  **Settings** > **Stylus** > **When stylus is removed**, then tap  next to **Show shortcuts**.

**Tip:** The stylus shortcuts show by default when the stylus is removed. To turn it off, swipe up  >  **Settings** > **Stylus** > **When stylus is removed** > **Show nothing**.

» **Open Moto Note when your phone is locked:** To launch Moto Note with your screen locked, remove the stylus from the slot. To switch this feature off, swipe up  >  **Settings** > **Stylus** > **Launch Moto Note when the stylus is removed**.

**Tip:** For more, see [Remove the stylus](#) and [Explore by touch](#).

## Direct Share

In some apps, you can share something directly to a contact, app, or conversation.

Select the share option within an app, then select a contact, choose an app, or type a name or number to find a contact.

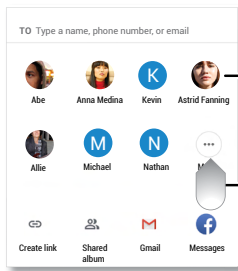

Tap a contact to share information.

Swipe up for more share options.

## Picture-in-Picture

If you're watching a video, on a video call, or using navigation, and you change screens, your video continues to play in a small window on your screen.

» Tap twice to return to it.

» Tap the  to close it.

» Swipe up from the bottom of the screen to put the video in a small window.

» Drag video around your screen.

**Note:** Not all apps support this feature.

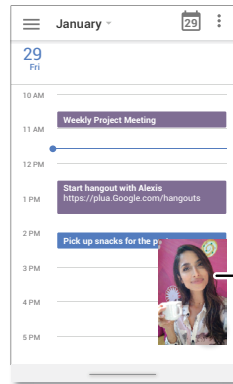

Tap the video twice to return to it.

# Customize your phone

## Redecorate your home screen



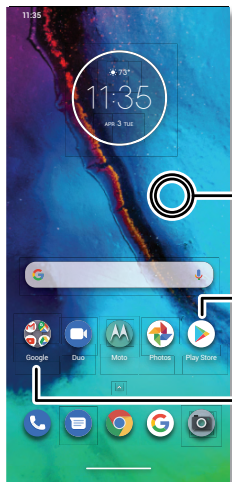

Customize your home screen the way you want.





Touch and hold an empty spot to change wallpaper.

Tap a shortcut to open.  
Touch and hold to move or delete.

Drag shortcuts on top of each other to make a folder.



- » **Change your wallpaper:** Touch and hold an empty spot on the home screen, then tap **Wallpapers**.
- » **Add a home screen page:** Drag an app to the right side of the home screen until a new page appears. You can add multiple pages.
- » **Adjust display settings:** Adjust brightness, font size, and screen saver. Swipe up  >  **Settings** > **Display**.
- » **Switch to dark theme:** Change your display to use dark theme, which saves battery and can be easier on your eyes. Swipe up  >  **Settings** > **Display** > **Advanced** >

### Dark Theme.

- » **Change your style:** Change your font and icon style. Touch and hold an empty spot and tap **Styles**.
- » **Rotate:** In many apps, the touchscreen switches from portrait to landscape when you rotate your phone. To turn this on or off, swipe up  >  **Settings** > **Display** > **Advanced** > **Auto-rotate screen**.

**Tip:** To see more home screen settings, touch and hold an empty spot and tap **Home settings**.





## Choose apps & widgets

- » **Add apps to the home screen:** Swipe up , touch and hold an app, then drag it to one of your home screen pages.
- » **Download new apps:** Tap  **Play Store**. For more on apps, see [App safety](#).
- » **Group apps together:** Drag one app onto another. Do it again to add more apps to the folder. To name the folder, tap it and enter a name below the apps.
- » **See app options:** Touch and hold an app. If the app has quick options (shortcuts), you'll see a list.
- » **Add widgets:** Touch and hold an empty spot on the home screen, tap **Widgets**, touch and hold a widget, then drag it to your home screen.
- » **Resize widgets:** You can resize some widgets—touch and hold a widget until you feel a vibration, then release. Drag the white circles at the edges to resize.
- » **Move or delete widgets and apps:** Touch and hold a widget or app and drag it to another spot, another page, or to  **Remove**.











**Note:** Removing an app from your home screen doesn't uninstall the app from your phone.

## Customize sounds & appearance

Customize your phone's sounds and display settings:

- » **Listen with Moto Audio by Dolby:** Swipe up  >  **Settings** > **Sound** > **Advanced** > **Moto Audio**. For more, see [Moto Audio](#).
- » **Set ringtone and notifications:** Swipe up  >  **Settings** > **Sound**.

**Tip:** Set notification sounds for individual apps within the app's settings.

- » **Night Light:** Set your screen to turn slightly amber colored at night. Swipe up  >  **Settings** > **Display** > **Night Light**.
- » **Add vibrate for calls:** To make your phone vibrate, swipe up  >  **Settings** > **Sound** and tap **Vibrate for calls**.
- » **Set a ringtone for a contact:** Swipe up  >  **Contacts**, tap the contact, then tap Menu  > **Set ringtone**.
- » **Change language:** Swipe up  >  **Settings** > **System** > **Languages & input** > **Languages**.
- » **Adjust font size:** Swipe up  >  **Settings** > **Display** > **Advanced** > **Font size**.

## Discover Moto

See [Moto](#) to set more custom features, like twisting your wrist twice to quickly open the camera, making a chopping motion to turn on the flashlight, and placing the phone face down to silence notifications and calls.

## Digital wellbeing and parental controls

Set limits on how much time you spend on your phone, get a bedtime reminder, and manage notifications.

**Find it:** Swipe up  >  **Settings** > **Digital Wellbeing & parental controls**

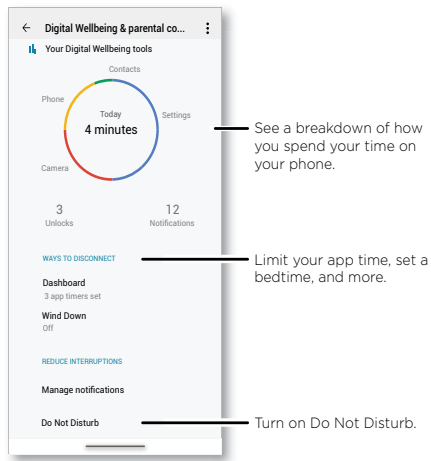

To supervise this phone remotely, view and set screen time limits, and add restrictions to services and apps, tap **Set up parental controls**.

# Apps





Your phone comes ready with some great apps. To find and add more apps, tap  **Play Store**. To learn more, see [App safety](#).

## Phone

Keep in touch by choosing a contact, returning a missed call, or using a voice command to start a call.

### Make a call



**Find it:**  **Phone**

- » **Call a contact:** To call a contact or recent call, tap the contact name.
- » **Dial a phone number:** To open the dialpad, tap . Enter a number, then tap  to call it.
- » **Voice dial:** To voice dial, tap  on the home screen or say “Hey Google”, then say “Call <name>”.
- » **Voicemail:**  appears in the status bar when you have new voicemail. To hear it, swipe down and tap the notification.
- » **Make a contact widget:** Touch and hold an empty spot on the home screen, tap **Widgets**, then touch and hold the **Direct dial** widget. Drag it to your home screen, then select the contact. Tap the widget to call the person.

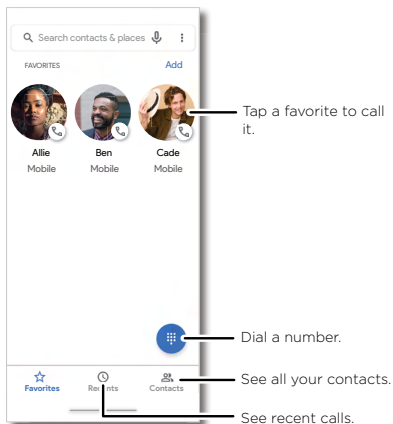
**Tip:** To enter the international dialing code (+), touch and hold **0**. To add a pause or wait after numbers, tap **Menu** .









### Receive a call

- » **Answer a call:** When your phone is locked, swipe  up to answer. When the phone is unlocked, tap **Answer**.
- » **Ignore a call:** When your phone is locked, swipe  down to reject the call and send it to voicemail. When the phone is unlocked, tap **Decline**.  
**Tip:** You can also press the Power button to ignore the call, or press a volume button to silence the ringer.
- » **Respond with a text:** When your phone is locked, tap  **Reply**, and select a message to respond.

**Note:** When you hold your phone to your ear, the touchscreen goes dark to avoid accidental touches. When you move the phone away from your ear, the screen lights up again. Don't use covers or screen protectors (even clear ones) that cover the proximity sensor above the touchscreen.



## During a call

- » **Mute a call:** Tap  **Mute** on the call screen to mute the call. You can hear your caller, but they can't hear you.
- » **Multi-task:** While you're on a call, swipe up from the bottom of the screen to look up a phone number, address, or open other apps. To reopen the call screen, swipe the status bar down and tap **Ongoing call**.
- » **Answer a second call:** To answer a second call, tap  **Hold and Answer Voice**. The first call is placed on hold. To switch between calls, tap  **Swap**.
- » **3-way call:** To join two calls together, answer the second incoming call while your first call is active, or tap  **Add call** to dial a second call. The first call is placed on hold. Tap  **Merge** to join the calls together.
- » **End a call:** Tap .

## Favorites

See all your favorite contacts together.





**Find it:**  **Phone** >  **Favorites**

To add favorites, tap  **Contacts**, scroll or search to find the contact, then tap .



## Recent calls

View your calls (with newest first), and then call, text, or store them:

**Find it:**  **Phone** >  **Recents**

- » To return a call, tap  next to the caller's name or number.
- » To send a text message, store the number, or other options, tap the caller's picture.
- » To remove an entry from the call log, touch and hold the name or number, then tap  **Delete**.
- » To clear the list, tap Menu  > **Call history** > Menu  > **Clear call history**.

## Caller ID and spam

**Find it:**  **Phone** > Menu  > **Settings** > **Caller ID & spam**

Tap **Filter spam calls** to prevent suspected spam callers from disturbing you.

To block a caller from calling again, tap  **Phone** >  **Recents**, touch and hold the



name or number, then tap  **Block/report spam**.



## Your phone number

**Find it:** Swipe up  >  **Settings** > **About phone** > **Phone number**

## Emergency calls

Your service provider programs one or more emergency phone numbers you can call under any circumstances, even when your phone is locked. Emergency numbers vary by country. Your pre-programmed emergency number(s) may not work in all locations, and sometimes an emergency call cannot be placed due to network, environmental, or interference issues.

- 1 Tap  **Phone** (if your phone is locked, drag up from the bottom of the screen to unlock it, then tap Emergency).
- 2 Enter the emergency number.
- 3 Tap  to call the emergency number.





**Note:** Your phone can use location based services (GPS and AGPS) to help emergency services find you. For more information, swipe up  >  **Settings** > **Location** > **Advanced** > **Emergency Location Service**.



# Messages







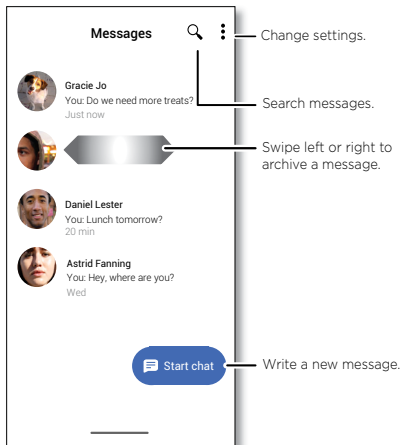



Stay in touch with messages and pictures. For tips on using the keyboard, see [Use the keyboard](#).

## Find it: Messages

- » **Create:** Tap .
- » **Attach:** When you're typing a message:
  - Tap  to attach a GIF or a contact, share your location, create a voice recording, and more.
  - Tap  to attach a photo from the gallery or take and attach a new photo.
- » **Send:** Tap  to send the message.
- » **Reply:** Open a conversation, then enter your response in the text box at the bottom and tap .



## Tips



- » **Add another contact to a message thread:** In a conversation, tap Menu  > **Details** > **Add people**.
- » **Delete thread:** To delete a whole thread of messages, touch and hold the thread, then tap  to delete, or swipe the message left or right.
- » **Save pictures:** Touch and hold a picture, and then tap  to save it. To see the picture, swipe up  >  **Photos**.
- » **Voice entry:** Tap a text box, then tap  on the keyboard.  
**Tip:** If you don't see  on the keyboard, swipe up  >  **Settings** > **System** > **Languages & input** > **Virtual keyboard** > **Google voice typing** to activate voice entry.
- » **Turn off notifications:** Stuck in a busy conversation? You can turn off notifications. Tap the thread, then tap Menu  > **Details** or **Group Details** > **Notifications**.

## Set your default messaging app

To set your default messaging app, swipe up  >  **Settings** > **Apps & notifications** > **Default apps** > **SMS app**, and select the messaging app to use as the default.



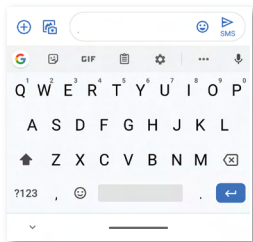

## Use the keyboard

When you tap a text box, like in a message or search, you have keyboard options.

- » **Type or gesture:** Enter letters by touching them one at a time. Or, enter a word by tracing a path through the letters. While you're typing, word suggestions appear above the keyboard. Tap one to select it.
- » **Voice entry:** Tap  on the touchscreen keyboard, then say what you want to type.
- » **Close the keyboard:** Tap .



See a different keyboard? It varies by app. This one is for texting.

- » **Symbols and numbers:** Touch and hold a letter to enter the number at the top of it. To enter symbols, tap .
- » **Capital letters:** Tap  for one capital letter. For all capital letters, tap  twice quickly.
- » **Keyboard options:** To customize your keyboard, swipe up  >  **Settings** > **System** > **Languages & input** > **Virtual keyboard** > **Gboard**.
- » **Cut, copy and paste:** Touch and hold a word to highlight it, tap **Cut** or **Copy**. Touch and hold the location you want to paste the text, and tap **Paste**.

## Chrome™





Access the Internet with the Chrome browser app.

**Find it:**  **Chrome**

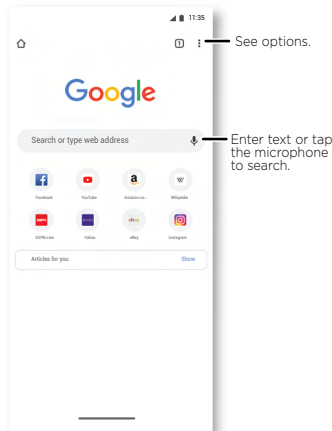





Or, from the home screen, tap the Google search box and enter or speak text to search.

**Note:** Your phone uses your Wi-Fi network (or your mobile phone network) to access the Internet. If you can't connect, contact your service provider. Your service provider may charge to surf the web or download data.





- » **Go to a web page:** Tap the address bar at the top of a page and enter an address.
- » **Add a bookmark:** Tap Menu  > .
- » **Open a bookmark:** Tap Menu  > **Bookmarks**.
- » **Web page shortcut:** To add a web page shortcut to your home screen, go to the web page and tap Menu  > **Add to Home screen**.
- » **Mobile sites:** Some websites automatically show you a "mobile" version of their

page—if you want to see the computer version of a website, tap Menu  > **Desktop site**.

- » **Reload:** If a page doesn't load correctly, tap Menu  > .
- » **Tabs:** To open a new tab, tap Menu  > **New tab**. To move from one tab to another, tap .
- » **Clear history:** In the browser, tap Menu  > **Settings > Privacy > Clear browsing data**. Then choose history, cache, cookies, and other options.
- » **Help:** For more about Google Chrome, tap Menu  > **Help & feedback** or visit <https://support.google.com/chrome>.

## Downloads

**Warning:** Apps downloaded from the web can be from unknown sources. To protect your phone and personal data from theft, download apps only on Google Play™.





- » **Files:** Tap the download link. To see the file, tap Menu  > **Downloads**.
- » **Pictures:** Touch and hold it, then tap **Download image**. To see the picture, tap  **Photos > Albums > Download**.

## Browser settings

To change your browser security settings, text size, and other options, tap Menu  > **Settings**.

## Safe surfing & searching

Keep track of what your browser and searches show:

- » **Incognito:** To open a tab that won't appear in your browser or search history, Menu  > **New Incognito tab**.
- » **Auto complete:** Your browser automatically fills in names and addresses, if you have entered the same information before. To turn off this feature, tap Menu  > **Settings > Addresses and more > Save and fill addresses**.  
**Tip:** Auto complete also fills in payment information, such as a credit card. To turn off this feature, tap Menu  > **Settings > Payment methods > Save and fill payment methods**.
- » **Pop-ups:** To stop pop-up windows from opening, tap Menu  > **Settings > Site**

**settings > Pop-ups and redirects**, then tap the switch to turn it off.



- » **Safe browsing:** To protect your phone from websites that might be unsafe, tap Menu  > **Settings > Sync and Google services > Safe Browsing**.

## Camera

Take crisp, clear photos with the back or front camera.

### Take photos

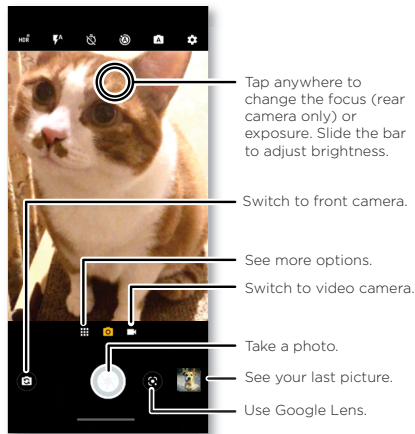

**Find it:**  **Camera**

- » **Take a photo:** Tap  to take a photo.
- » **Take a selfie:** Tap  in the camera screen to switch to the front camera.
- » **Zoom:** Swipe up or down. (Or pinch two fingers together.)
- » **Multi-shot:** Touch and hold  to take a burst of photos.













## Record videos

**Find it:**  **Camera**, then tap 













Tap  to start recording. Then tap  to stop recording. Tap  on the screen while recording to save a photo.

## Camera settings

Point, tap, and you're done, or play with these camera options. You can find these options along the top of the camera or video screen:

Options	
 <b>HDR</b>	Turn on HDR (high dynamic range) effect for better pictures in challenging lighting situations, such as outdoors.
 <b>Flash</b>	Set to <b>On</b> , <b>Off</b> , or <b>Auto</b> . For front-facing cameras with flash, you can also turn the <b>Torch</b> or <b>Flashlight</b> on or off. <b>Note:</b> For front-facing cameras, you may see a flash or a white screen before the photo is taken.
 <b>Beautify</b>	With the front-facing camera, smooth skin and beautify faces. Set to <b>Auto</b> , <b>Manual</b> , or <b>Off</b> .
 <b>Timer</b>	Set a timer to 3 or 10 seconds.
 <b>Active photos</b>	Turn on to capture a brief photo in motion of your subject.
 <b>Auto/Manual</b>	Control professional camera settings. Set to <b>Auto</b> or <b>Manual</b> .
 <b>Torch</b>	In video mode, turn on a flashlight (with the back camera only).
 <b>Stabilization</b>	In video mode, remove some of the shakiness of the video.
 <b>Video</b>	Take a video.
 <b>Photo</b>	Take a photo.

To find these options, tap Menu  or swipe right on the camera screen:

Options	
 <b>Portrait</b>	Take portraits using special enhancements and effects. For more, see <a href="#">Take portraits</a> .
 <b>Cutout</b>	Cut out the subject in the foreground and replace the background. For more, see <a href="#">Change or add your portrait's background</a> .
 <b>Macro</b>	Take a macro photo or video.
 <b>Spot color</b>	Pick one color from the viewfinder while everything else becomes black & white.
 <b>Night Vision</b>	Take photos in low light situations.
 <b>Cinemagraph</b>	Freeze parts of a video for an artistic effect.
 <b>Panorama</b>	Take a wide-angle shot. Use the on-screen guide to slowly pan while you are taking the photo.
 <b>Live filter</b>	Choose a filter to apply to your photo.
 <b>Slow motion</b>	Take a video that will play in slow motion.
 <b>Timelapse</b>	Take a video using timelapse to make a longer video play faster. You can set the playback speed as <b>4x</b> , <b>8x</b> , <b>16x</b> , and <b>32x</b> (times) faster than a regular video.
 <b>Help</b>	See help for using the camera.
 <b>Live stream</b>	Broadcast your video live on social media.
 <b>YouTube live</b>	Broadcast your video live on YouTube™.

To find these options, tap .

Options	
<b>Photo size (rear or selfie camera)</b>	Set the photo resolution for the camera.
<b>Video size (rear or selfie camera)</b>	Set the video resolution.
<b>Action Cam video size</b>	Set the Action Cam Video size.
<b>Slow motion size</b>	Set the video resolution for a slow motion video.
<b>HDR</b>	Turn on HDR (high dynamic range) effect for better pictures in challenging lighting situations, such as outdoors.
<b>Selfie photo mirror</b>	Turn on to take a mirrored selfie. Note that the viewfinder will not show a mirrored selfie, but the photo will be mirrored after you take it. (If your phone has Active Photos, it must be turned off to use this feature.)
<b>Quick capture</b>	Twist twice to open or switch between front and back cameras.
<b>Tap anywhere to capture</b>	Capture photos or videos by tapping anywhere on the screen. Zoom by scrolling up or down with one finger.
<b>Shutter sound</b>	Turn the shutter sound on or off.
<b>Assistive grid</b>	Overlay a grid to help align the subjects in your photos or videos.
<b>Leveler</b>	Take perfectly level photos using a guide line in the viewfinder.
<b>Watermark</b>	Add a watermark or signature to your photos.
<b>Auto smile capture</b>	Automatically detect smile and take a photo when all of the subjects (limited to five faces) in the viewfinder are smiling.

Options	
<b>Gesture selfie</b>	Hold up your palm to start a two-second timer to take a selfie.
<b>Smart composition</b>	Generate an alternate shot that uses the professional photography rule of thirds.
<b>Shot optimization</b>	Turn on automatic tuning and scene detection.
<b>Google Lens</b>	Find out more about the things you see in the viewfinder. See <a href="#">Identify items using Google Lens™</a> .
<b>Storage</b>	Choose a storage location for your photos and videos ( <b>Phone</b> or <b>Memory card</b> ).
<b>Save location</b>	Turn on to tag photos with a location.

## Take portraits

You can use the portrait mode to add a blur effect and make portions of your photo black and white, while keeping the main subject in perfect focus.

**Find it:**  **Camera** > Menu  >  **Portrait**



- 1 Line up your subjects. The closest subject is prioritized automatically. Tap the screen to change the focal point.
- 2 Slide the bar to increase or decrease the background blur.
- 3 Tap  to take the photo and hold your camera steady.

**Tip:** For best results, subjects should be 2-6 feet away and not side-by-side. When photographing people, aim for the waist up.

## Take close ups and change the background

Use cutout mode to get a close portrait, cut it out from the background, and replace the background with something else.

**Note:** Available when using the back camera only.

**Find it:**  **Camera** > Menu  >  **Cutout**

1 Line up your subject at close range.

2 Tap  to take the photo and hold your camera steady.

**Tip:** When photographing people, aim for the face. After taking the photo, use the photo editor to change the background. See [Change or add your portrait's background](#).

## Identify items using Google Lens™

Search landmarks, products, explore books, identify plants and animals, copy text, scan barcodes, QR codes, business cards, and more.

**Find it:**  **Camera** > 

1 Focus your camera on an object, landmark, or code until a circle appears on the object in your viewfinder.

2 Tap the circle.

Depending on the object, you can see the details, take an action, or find more products.

**Tip:** Focus your camera on a book cover, tap the screen to see the book title and author.

**Note:** Google Lens may not work in all languages.

## Capture your screen

There's more than one way to capture your phone's screen.

» Press and hold the Power button and tap **Screenshot**.

» Press and hold both the Power and the Volume Down buttons at the same time.

» Set up [Moto Actions](#) so you can capture screenshots by touching the screen with three fingertips.



» Remove the stylus, then tap  when the stylus shortcuts appear.

**Tip:** To see the screen capture, tap  **Photos** > **Albums** > **Screenshots**.

## Photos



### View, edit & share

**Find it:**  **Photos**

» **View, share, or delete:** Tap a thumbnail to open it, then tap  to share,  to delete, or Menu  for more options.

**Tip:** To select multiple files, open a folder, touch and hold a photo, then tap others. Or group photos in an album and share the whole album.

» **Zoom:** Open a photo in your gallery, then double-tap or drag two fingers apart or together on the screen.

**Tip:** Turn your phone sideways for a landscape view. To turn Auto-rotate screen on or off, swipe up  >  **Settings** > **Display** > **Advanced** > **Auto-rotate screen**.

» **Wallpaper or contact photo:** Open a picture, then tap Menu  > **Use as** > **Wallpaper** or **Contact photo**.

» **Edit:** Open a picture, then tap 

» **Slideshow:** Tap a picture, then tap Menu  > **Slideshow**. To stop the slideshow, tap the screen. To show the slideshow on a television or other device, see [Connect, share & sync](#).

**Tip:** For more about Google Photos™, visit <https://support.google.com/photos>.

## Change or add your portrait's background

**Note:** To take a Cutout mode photo, tap  **Camera** > Menu  >  **Cutout**.

Cutout photos show  at the top of the thumbnail.

**Note:** Available when using the back camera only.

1 Tap a cutout photo and tap Edit  > **Add Background**.

2 Select a background image.



3 Tap **Save** to save a copy of the photo with your changes.



# Gmail

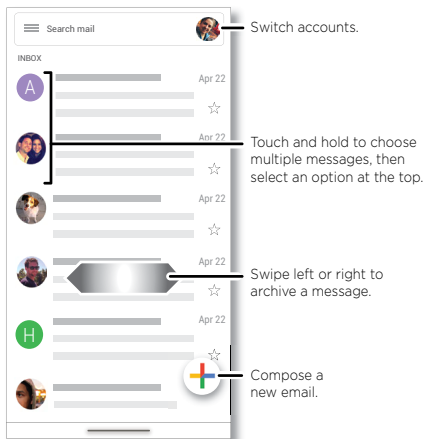

Send and receive email from all of your personal accounts (even if they're not Gmail accounts). You can manage your accounts in Gmail and easily switch between them.

**Find it:** Swipe up  >  **Gmail**



- » **Add Gmail accounts:** The first time you turned on your phone, you probably set up or logged in to your Google account—that sets up the  **Gmail** app for one account. To add more Google accounts, swipe up  >  **Settings** > **Accounts**, then tap **+ Add account** > **Google**.

**Tip:** In the  **Gmail** app, tap  > **Settings** > **Add account**.

- » **Add email accounts:** The Gmail app manages all of your email accounts. To add other personal email accounts to the Gmail app, swipe up  >  **Settings** > **Accounts** > **+ Add account**. For Microsoft® Exchange server work email accounts, tap **+ Add account** > **Exchange**, and enter details from your IT administrator.
- » **Change account settings:** To change the settings for a Gmail or email account, swipe

up  >  **Gmail** >  > **Settings**, then tap the account name.



- » **Delete accounts:** Swipe up  >  **Settings** > **Accounts**, then tap the account name and **Remove account**.

# Duo

Sign in with your Google account to make and receive video calls.

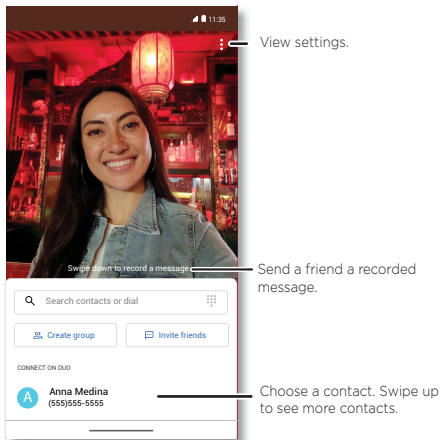
**Find it:** Swipe up  >  **Duo**



- » **Start a new video call:** Tap the search box, then type or tap a name in your contacts to start the video call.
- » **Preview incoming calls:** See live video of the caller before you answer. To turn this off for both the caller and receiver, tap Menu  > **Settings** > **Call settings** > **Knock Knock**.
- » **Change settings:** Tap Menu  > **Settings** to change the vibration setting, block numbers, and more.

» **Call anyone:** Duo works across platforms, allowing you to call friends with the Duo app on any device.

**Tip:** When on a video call, your phone will automatically switch from cellular network to Wi-Fi, if available.

## Moto

Explore special features designed to save you time and make your day easier.

**Find it:**  **Moto** > 

- » **Moto Actions:** Use gestures as phone shortcuts.
- » **Moto Display:** See your notifications at a glance.
- » **Moto Gametime:** Find features and tools for gaming.

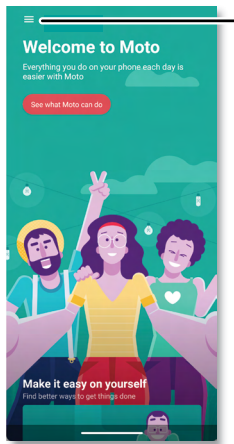

**Note:** Your phone may not have all features.



Tap to open Moto app features, or swipe up from the bottom of the screen.

## Moto Actions



Enhance your phone with gestures and actions.

**Find it:**  **Moto** >  > **Moto Actions**



- » **Quick Capture:** Twist your wrist twice quickly to open the camera.
- » **Fast flashlight:** Turn the flashlight on/off with two chopping motions.
- » **Three finger screenshot:** Touch and hold the screen with three fingertips to capture a screenshot.
- » **Screenshot editor:** Edit and share your screenshots.
- » **Flip for DND:** Place the phone face down to silence notifications and calls.
- » **Pick up to silence:** Lift the phone to switch incoming calls to vibrate.
- » **Media controls:** Use the volume buttons to change music tracks when the screen is off.
- » **Swipe to shrink:** Swipe down to the left or right corner to make the screen smaller for one-handed use.

## Moto Display

See notifications, keep the screen on when you're looking at it, and reduce blue light in the evenings.

**Find it:**  **Moto** >  > **Moto Display**

- » **Peek Display:** Battery friendly notifications fade in and out while the screen is off to show you what's going on. Tap the switch to turn it on, then tap **Peek Display** > **Settings** to customize gestures and notifications.
- » **Attentive Display:** Your screen won't dim or sleep while you're looking at it.

**Note:** Notification display settings can also be set by swiping up  >  **Settings** > **Apps & notifications** > **Notifications**.

## Moto Gametime

Enhance your gaming experience.

**Find it:**  **Moto** >  > **Moto Gametime**

Tap **Game mode**, tap the switch to turn it on, then choose from options, such as audio



and visual enhancements, do not disturb mode, and shortcuts to your favorite games.

## Moto Audio

Customize your sound or let Moto Audio, tuned by Dolby, handle it for you.

**Find it:** Swipe up ^ >  **Moto Audio**

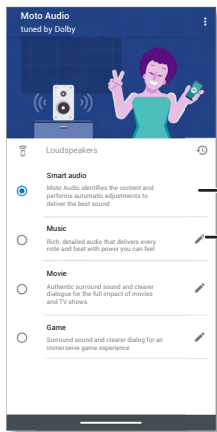

Keep Smart audio on for sound to adjust automatically.



Or set the audio levels for an audio type.

## Moto Note

Use your fingers or the stylus to create, edit, and share notes.

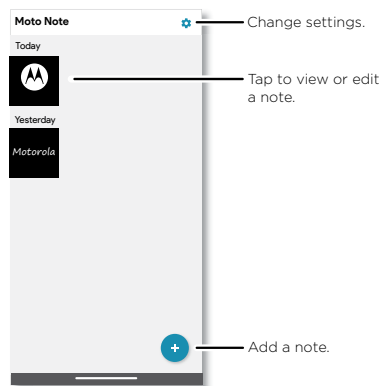
**Find it:** Swipe up ^ >  **Moto Note**



» **Create a note:** Tap . To save or share the note you have created, tap  or .

» **Edit a note:** Tap a thumbnail to view or edit a note.

» **Share or delete:** Tap a thumbnail and hold, then tap  or .

» **Use your finger as an eraser:** Tap  > **Finger eraser**.

» **Add a timestamp watermark:** Tap  > **Moto Note watermark** to show a timestamp watermark on your note.

# Calendar

See all your events, all in one place.

**Find it:** Swipe up  >  **Calendar**

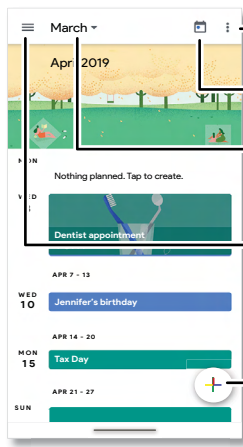

Tap to refresh the Calendar screen.

Go to today's date.

Jump to a different month.

Change the calendar view, adjust settings, get help, and more.



Add a new event.

» **Change the view:** Tap the month at the top to choose a date to view. Or tap  to choose **Schedule**, **Day**, **3 Day**, **Week**, or **Month**.

» **Go to today's date:** Tap  at the top. (If you have an appointment that day, you'll see a dot in the icon.)

» **Add events, reminders, or goals:** Tap  > **Event**, **Reminder** or **Goal**, enter details, then tap **Save**.

**Tip:** In most views, tap a time on the calendar to enter event details.

» **Show, edit, or delete events:** Tap an event to open it, then tap  to edit it, or tap Menu  > **Delete** to remove the event.

» **Show, hide, or add calendars:** Tap , and select which options, such as events, reminders or other calendars, to show or hide. You can use a computer to add or remove calendars on your Google account at [www.google.com/calendar](http://www.google.com/calendar).

**Tip:** Add a **Calendar** widget to your home screen. Touch and hold an empty spot on the home screen, tap **Widgets**, then touch and hold a calendar widget and drag it to your home screen.

## More apps

### Google Play

Google Play is a digital content experience from Google where you can find and enjoy your favorite music, movies, TV shows, books, magazines, and Android apps and games.

» **Download apps:** Tap  **Play Store**.

» **Log in or open a Google account:** Visit [www.google.com/accounts](http://www.google.com/accounts).

» **Google help:** See [www.google.com/support](http://www.google.com/support).

## Contacts

Combine information from your Google contacts and social networks for quick access to everyone you know.

**Tip:** You can find most of these features on the 👤 **Contacts** tab in the Phone app. See [Phone](#).

**Find it:** Swipe up ^ > 👤 **Contacts**

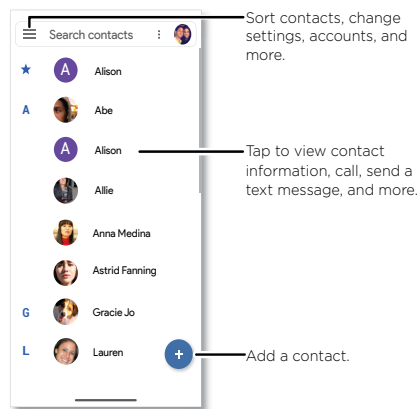

Sort contacts, change settings, accounts, and more.

Tap to view contact information, call, send a text message, and more.

Add a contact.

- » **Add a contact:** Tap +.
- » **Edit or delete:** Tap a contact, then tap  or tap Menu ☰ > **Delete**.
- » **Call, text, or email:** Tap a contact, then tap an option. (If the contact doesn't have an email address, you can set up and use Google Duo.)
- » **Search contacts:** In the **Contacts** list, tap **Search contacts**.  
**Tip:** From the home screen, tap the Google search box and enter a contact's name.
- » **Share a contact:** Tap a contact, then tap Menu ☰ > **Share** to send it in a message or email, via a Bluetooth connection, or save to Google Drive™.

**Tip:** Tap a contact, then tap Menu ☰ > **Add to Home screen** to add a shortcut for the contact on your home screen.

- » **Synchronize:** On your phone, swipe up ^ > ⚙️ **Settings** > **Accounts**, and choose your Google account. Then tap **Account sync** > Menu ☰ > **Sync now**. You can also see these contacts at [www.gmail.com](http://www.gmail.com).
- » **Add your details:** To store your user profile, tap ☰ > **Settings** > **Your info**.

## Favorites

Set your most-used contacts as favorites, so you can get to them faster.

- » To set a favorite, swipe up ^ > 👤 **Contacts**, select a contact and tap ☆.
- » To see your favorites, tap 📞 **Phone** > ★ **Favorites**.

## Get contacts

Get all your contacts in one place.

- » To add your social networking contacts, swipe up ^ > ⚙️ **Settings** > **Accounts**, then tap **Add account**.
- » To add your email contacts, see [Gmail](#).

**Tip:** If you add an **Exchange** account, you can send messages to your coworkers, even if you don't have them stored in your contacts.

- » To import contacts from your SIM card (if it didn't happen automatically), swipe up ^ > 👤 **Contacts** > Menu ☰ > **Settings** > **Import** > **SIM card**. Tap **OK** to confirm.
- » To import contacts from your computer, upload the contacts to your Google account at <http://contacts.google.com>. On your phone, swipe up ^ > 👤 **Contacts** > Menu ☰ > **Settings** > **Accounts** > **Automatically sync data**. You can also see these contacts at <http://mail.google.com>.

For help with transferring contacts, go to [www.motorola.com/transfercontacts](http://www.motorola.com/transfercontacts).

## Maps

Find a nearby cafe, get directions or step-by-step GPS voice navigation using Google Maps™.

**Find it:** Swipe up  >  **Maps**

Enter what you want to find in the search bar, or tap  to search by voice.

**Note:** Your map screen may look different.

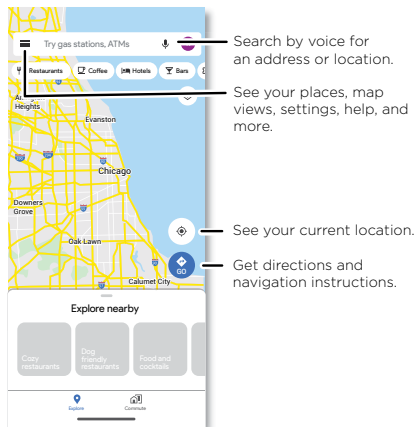

» **Find an address:** In the search field, type an address or something you're looking for, like "restaurant." Tap an item to see more, or tap **Directions**, **Call**, or **Share**.

» **Get directions:** Tap  **GO**, then enter a place or address.

» **Zoom:** To zoom in or out, drag two fingers together or apart on the screen.

» **Turn and tilt:** Rotate two fingers on the map to turn it, or drag up/down to tilt.

» **Identify address:** Touch and hold a spot on the map to show the nearest address.

» **Get map help:** Tap  > **Help**.

For more on maps, visit [support.google.com/maps](https://support.google.com/maps).

## Drive

Keep all your photos, videos, documents, and more safely in one place—private unless you choose to share. Available on Google Drive™ from all your devices.

**Find it:** Swipe up  >  **Drive**

» To create a new file or folder, tap .

» To open a file, tap it.

» To edit a document, tap anywhere in the text to begin typing.

## Music, movies, TV & YouTube

### Music

Music everywhere—stream it, buy it, save it, play it. Listen and create playlists anytime.

**Find it:** Swipe up  >  **Play Music**

To upload your music library to Google Play Music, from a computer, visit [www.google.com/music](https://www.google.com/music).

**Tip:** Share songs directly with your contacts. Tap Menu  next to a song and tap **Share**. See [Direct Share](#).

For more on the Play Music app, see [support.google.com/music](https://support.google.com/music).

**Note:** Copyright—do you have the right? Always follow the rules. See **"Content Copyright"** in the legal and safety information on your phone.

### FM Radio

**Find it:** Swipe up  >  **FM Radio**

Plug in a headset, then use the arrows to tune to a higher/lower frequency station.

**Note:** Your phone has the Frequency Modulation (FM) broadcast receiver functionality for reception without data usage. The phone will perform an auto tuning for the radio channels with the best signal.

### Movies & TV

Find and rent movies and TV shows to watch on your phone, tablet, or computer:

**Find it:** Swipe up  >  **Play Movies & TV**

To shop, rent, or watch on a computer, go to [play.google.com/store/movies](https://play.google.com/store/movies).







## YouTube™



Watch videos and podcasts from YouTube users everywhere—or log in to your account to share your own.

**Find it:** Swipe up  >  **YouTube**

## Clock

**Find it:** Swipe up  >  **Clock**

Options	
<b>Alarm</b>	Tap  . Tap an alarm to edit it, or tap  to add a new alarm. <b>Tip:</b> Pressing the volume button up or down sets the volume level for that alarm. When an alarm sounds, tap and drag to  to turn it off, or drag to  to snooze for ten minutes.
<b>Clock</b>	To change your alarm volume, snooze delay, or other settings, tap Menu  > <b>Settings</b> . For other time zones, tap <b>Home time zone</b> .
<b>Timer</b>	For a timer, tap  .
<b>Stopwatch</b>	For a stopwatch, tap  .

**Tip:** To set your current date, time, time zone, and formats, swipe up  >  **Settings** > **System** > **Date & time**.

# Connect, share & sync

Connect accessories, computers, networks, and more.

## Connect with Wi-Fi

### Turn Wi-Fi power on/off



**Find it:** Swipe up  >  **Settings** > **Network & internet**, then tap the switch to turn it on

When Wi-Fi is on, your phone automatically reconnects to available networks it has used before.

**Note:** You can also turn Wi-Fi on and off in [Quick settings](#).

### Connect to networks

To find networks in your range:

- 1 Swipe up  >  **Settings** > **Network & internet** > **Wi-Fi**.
- 2 With Wi-Fi turned on, tap a found network to connect to it. When connected, you'll see  in the status bar.

**Note:** If you see a question mark in the Wi-Fi status indicator , swipe the status bar down, tap the network, and enter the network's password.

### Wi-Fi hotspot

You can make your phone a Wi-Fi hotspot to provide portable, convenient Internet access to other Wi-Fi enabled devices. Your phone turns off Wi-Fi and uses the mobile network for Internet access. This feature may require an additional subscription service from your service provider.

**Find it:** Swipe up  >  **Settings** > **Network & internet** > **Hotspot & tethering** > **Wi-Fi hotspot**

**Note:** These steps may vary depending on your network.

To set up security:

- **Hotspot name:** Enter a unique name for your hotspot.
- **Hide my device:** Hide your hotspot from other devices.

- **Security:** Select the type of security you want: **None** or **WPA2-Personal**. For **WPA2-Personal**, enter a unique password (8 characters) that others will need to access your Wi-Fi hotspot.

**Note:** To change your hotspot password or turn off hotspot automatically, tap **Advanced**.

## Connect with Bluetooth wireless

### Turn Bluetooth power on



To turn Bluetooth on, swipe the status bar down and touch . Touch and hold it to open Bluetooth settings.

**Note:** Your phone automatically turns on Bluetooth power when you connect to a paired device.

**Tip:** To extend battery life or stop connections, turn Bluetooth off when you're not using it.

### Connect devices

The first time you connect a Bluetooth device, follow these steps:

- 1 Make sure the device you are pairing with is in discoverable mode (for details, refer to the guide that came with the device).
- 2 Swipe up  >  **Settings** > **Connected devices** > **Pair new device**.
- 3 With Bluetooth turned on, tap a found device to connect it (if necessary, tap **Pair** or enter a passkey like **0000**). You can tap  to rename the device and choose what the device will be used for.



When the device connects, the Bluetooth connected indicator  appears at the top of the screen.

To automatically **disconnect** or **reconnect** a device, just turn the device off or on.



**Note:** Using a mobile device or accessory while driving may cause distraction and may be illegal. Always obey the laws and drive safely.

### Transfer files

- » **Photos or videos:** Open the photo or video, then tap  > **Bluetooth**.

- » **Contacts:** Swipe up  >  **Contacts**, tap a person, then tap Menu  > **Share** > **Bluetooth**.

### Bluetooth tethering

To share your phone's internet connection via Bluetooth, swipe up  >  **Settings** > **Network & internet** > **Hotspot & tethering** and tap the switch to turn on **Bluetooth tethering**.

### Share files with your computer

**Note:** Copyright—do you have the right? Always follow the rules. See “Content Copyright” in the legal and safety information on your phone.

### USB

To load music, pictures, videos, documents, or other files from your computer, connect your phone to your computer with a USB cable. To change the type of USB connection, swipe the status bar down and tap **Android System** > **USB Preferences** > **File transfer**.

**Tip:** Make sure to connect the phone to a high power USB port.

**Note:** The first time you use a USB connection, your computer may indicate that drivers are being installed. Follow any prompts you see to complete the installation. This may take a few minutes.

- » For Microsoft® Windows®: On your computer, choose Start > Windows Explorer. Your phone will appear as a connected drive where you can drag and drop files. For more instructions or driver files, visit [www.motorola.com/support](http://www.motorola.com/support).
- » For Apple™ Macintosh™: Use Android File Transfer, available at [www.android.com/filetransfer](http://www.android.com/filetransfer).

### Virtual Private Network (VPN)

A VPN lets you access files on a secured network (like an office network with a firewall). Contact the network administrator for VPN settings, and any additional apps or requirements.

To enter VPN settings, swipe up  >  **Settings** > **Network & internet** > **Advanced** > **VPN**. Tap  to add a new VPN. Choose the type of VPN and enter settings from the network administrator. Select the VPN name to connect.

## Share your data connection

Your computer can access the Internet through your phone's mobile network—you just need a USB cable.

**Note:** Your phone turns off Wi-Fi and uses the mobile network for Internet access. This feature may require an additional subscription service from your service provider.

1 Connect your phone to your computer using a USB cable.



**Note:** If your computer is running something older than Microsoft Windows 7 or Apple Macintosh OSX, it might require special configuration.

2 On your phone, swipe up  >  **Settings**, and make sure **Wi-Fi** is off.

3 In **Settings**, tap **Network & internet** > **Hotspot & tethering**, then tap the **USB tethering**.

To stop the connection, tap **USB tethering** again, then disconnect your phone from your computer.

## Print



To print your photos, documents, and more from your phone, check if your printer's manufacture has an app on Google Play. Then swipe up  >  **Settings** > **Connected devices** > **Connection preferences** > **Printing** to get started.

You can also send your photos, docs, and more to any Android device in your cloud or to Google Drive. Just download the Cloud Print app from Play Store.

## Sync to the cloud

One account with access to everything, everywhere—phone, tablet, computer.

### Sync your Google account

When you log in to the same Google account, all devices can get to all the same apps, movies, books, and music from Google Play—plus you share the same Gmail, Google Calendar™, and Google Mobile™. To add Google accounts to your phone, swipe up  >  **Settings** > **Accounts** > **Add account** > **Google**.



## Phone & tablet

Your Android phone and tablet can work together to help you get the most out of both:

- » **Transfer media and files:** Copy files to your phone and transfer them to other devices—see [Transfer files](#).
- » **Phone hotspot:** If you have a Wi-Fi tablet, turn your phone into a Wi-Fi hotspot to let your tablet access the Internet anywhere—see [Wi-Fi hotspot](#).
- » **Bluetooth® accessories:** If you have a Bluetooth keyboard or other accessories to use with your tablet, remember you can use them with your phone too. To connect them, see [Connect with Bluetooth wireless](#).

## Cast your screen to a TV

To cast (mirror) your screen on a TV, showing all apps and screens you use on your phone, you'll need to use a TV with Chromecast built-in, or plug a Chromecast™ device into your TV's HDMI port.

- 1 Make sure your phone and TV/Chromecast device are connected to the same Wi-Fi network.
- 2 On your phone, swipe up  >  **Settings** > **Connected devices** > **Connection preferences** > **Cast**.
- 3 Tap the name of the TV/Chromecast device to connect.

**Note:** To stop casting, on the casting notification, tap  > **Disconnect**.



## Use a memory card

You can move pictures, videos, audio, and other media files from internal phone storage to a microSD card (sold separately).

**Note:** Your phone supports microSD cards up to 512GB. Use a Class 10 (or higher) microSD card for best results.



### Move files from your phone to a memory card

To move files to a microSD card (sold separately):

- 1 Swipe up  >  **Settings** > **Storage**, then tap the SD card name.
- 2 Touch and hold a folder or a particular item, then tap Menu  > **Move to...**

## Mount or unmount memory card

To mount a microSD card, just put it in your phone (see [Insert the SIM and microSD cards](#)).

To unmount your microSD card (so you can take it out of your phone), swipe up  >  **Settings** > **Storage**. Then tap  next to the microSD card name.

**Caution:** Do not remove a microSD card while your phone is using it or writing files to it.

## Airplane mode

Use airplane mode to turn off all your wireless connections—useful when flying. Swipe the status bar down and tap **Airplane mode** .

**Note:** When you select airplane mode, all wireless services are disabled. You can then turn Wi-Fi and/or Bluetooth power back on, if permitted by your airline. Other wireless voice and data services (such as calls and text messages) remain off in airplane mode. Emergency calls to your region's emergency number can still be made.

## Mobile network

You should not need to change any network settings. Contact your service provider for help.

To see network settings options, swipe up  >  **Settings** > **Network & internet** > **Mobile network**.

## Protect your phone

Make sure your information is protected in case your phone is lost or stolen.

### Screen lock

The easiest way to protect your phone is to lock your touchscreen when you are not using it. You can choose the best method for you to unlock your phone.

**Find it:** Swipe up  >  **Settings** > **Security**

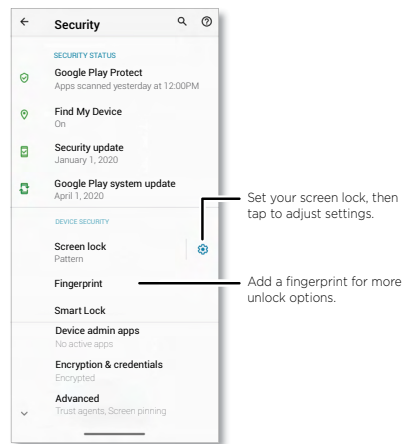



**1** Tap **Screen lock** and select the lock type:

- » **None:** Turn off the screen lock.
- » **Swipe:** Drag up from the bottom of the screen to unlock.
- » **Pattern:** Draw a pattern to unlock.
- » **PIN:** Enter four to sixteen digits to unlock.
- » **Password:** Enter four to sixteen letters, digits, or symbols to unlock.



2 After setting the lock type, tap  for screen lock settings.

To change when your touchscreen goes to sleep, swipe up  >  **Settings** > **Display** > **Advanced** > **Screen timeout**.

**Note:** You can make emergency calls on a locked phone (see [Emergency calls](#)). A locked phone still rings, and you do not need to enter a PIN or password to answer a call.

## Smart lock

Keep your phone unlocked when it's safe with you.

**Find it:** Swipe up  >  **Settings** > **Security** > **Smart Lock**

- » Tap **On-body detection** to keep your phone unlocked when it's in motion.
- » Tap **Trusted places** and **Trusted devices** to add locations and nearby devices that will keep your phone unlocked.
- » Tap **Voice Match** to access the Google Assistant, email, calendar and more when your phone is locked.

## Unlock with your fingerprint

You can use the fingerprint sensor to unlock your phone.

**Find it:** Swipe up  >  **Settings** > **Security** > **Fingerprint**

## Can't unlock?

If you forget your pattern, PIN, or password, you can enter your Google account email and password on another device to unlock the phone.

If you don't have a Google account on your phone, contact your service provider to have your phone factory reset.

**Warning:** A factory reset will delete all data on your phone.

## Your privacy

Keeping your information safe is important.

**Find it:** Swipe up  >  **Settings** > **Privacy**

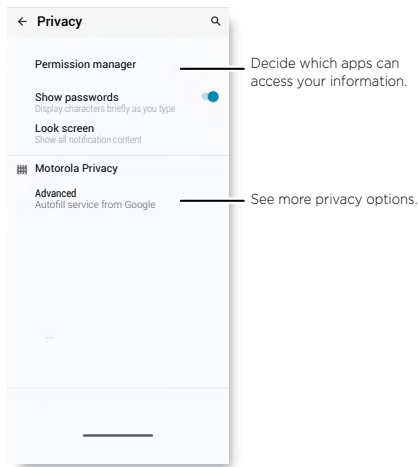



Tap **Permission manager** to see which apps have permissions to access private information, such as calendar events, contacts, email, and your location.

Tap an app, then tap one of the apps that have permissions and tap **Allow** or **Deny**.



**Note:** Some apps, such as Map, request your location in order to provide information, like directions or helping you find a nearby gas station. Turning off permissions may cause an app not to function correctly.

## Passwords

Your phone briefly shows password characters as you type. To turn this off, swipe up  >  **Settings** > **Privacy** > **Show passwords**.



## Notifications

Your phone shows notifications even when it's locked.

To choose which notifications show, swipe up  >  **Settings** > **Privacy** > **Lock screen**. Tap to show all, none, or only those that are not sensitive.



## Location

Location services, like GPS, Wi-Fi, mobile networks, and sensors help estimate your phone's location.

To see recent location requests and which apps can determine your phone's location, swipe up  >  **Settings** > **Location**. Tap **App permission**, then tap an app. Choose **Allow only while using the app** or **Deny**.

## Screen pinning

Need to keep an important screen handy, like a boarding pass or shopping coupon? Pin the screen for easy access.

**Find it:** Swipe up  >  **Settings** > **Security** > **Advanced** > **Screen pinning**, then tap the switch to turn it on

To pin a screen, swipe up and hold to see recent apps. Tap the icon at the top of the app and tap  **Pin**.

To unpin the screen, swipe up and hold.

## Backup & restore

**Find it:** Swipe up  >  **Settings** > **System** > **Backup** > **Back up to Google Drive**

Your Google account data is backed up online. If you reset or replace your phone, just log in to your Google account to restore the contacts, events, and other details you synced with the account.

To restore your Google Play apps, see [Take care of your apps](#).

## App safety

**Tip:** Choose your apps and updates carefully, as some may impact your phone's performance—see [Choose carefully](#).



## Apps from Google Play



Get music, movies, books, apps, games, and more.

**Find it:**  **Play Store**

## Apps from the Internet



You can get apps from other online app stores using your browser.

**Tip:** When installing an app, make sure you read the alerts that tell you what information the app will access. If you don't want the app to access this information, cancel the installation, or set strong privacy permissions: swipe up  >  **Settings** > **Privacy**.

To let your phone install apps that are not on Google Play, swipe up  >  **Settings** > **Apps & notifications** > **Advanced** > **Special app access**, then tap **Install unknown apps** and choose which apps are allowed to install them.



## Choose carefully

Here are a few tips:

- » To help prevent spyware, phishing, or viruses, use apps from trusted sites, like  **Play Store**.
- » Check the app's ratings and comments before installing. If you doubt the safety of an app, don't install it.
- » Apps use up memory, data, battery, and processing power—some more than others. If you're not happy with how much memory, data, battery or processing power an app is using, uninstall it.
- » Monitor children's access to apps to help prevent exposure to inappropriate content, and set limits on phone use: swipe up  >  **Settings** > **Digital Wellbeing & parental controls**.
- » Certain apps may not provide completely accurate information. Take care, especially when it comes to personal health.

## Set app permissions

You may be asked for permissions when you use a feature in an app.

To modify the app permissions settings, swipe up  >  **Settings** > **Apps & notifications** > **Advanced** > **Permission manager**, then tap a feature (such as



microphone) to see which apps have permissions to use it. Tap **Allow** or **Deny** to turn the permission on or off.



## Take care of your apps

» **Uninstall apps:** To remove an app from your phone, touch and hold the app, then drag it to **Uninstall**.



To remove an app from the home screen, touch and hold the app, then drag it to **Remove**. The app isn't removed from your phone, just the home screen.

**Note:** Not all apps can be uninstalled, but they can be disabled.

» **Disable/Stop apps:** To disable an app or force it to stop running, swipe up  >  **Settings** > **Apps & notifications**. Tap an app, then tap **Disable** or **Force stop**. To enable it, tap **Enable**.

» **Reinstall apps:** To reinstall apps from Google Play, swipe up  >  **Play Store**, then tap  > **My apps & games** > **Library**. The apps you've used before are listed and available for download.

» **See app details:** Touch and hold an app, then tap .

» **See app data usage:** To show which apps are using the most data, swipe up  >  **Settings** > **Network & internet** > **Mobile network** > **App data usage**. For more, see [Data usage](#).

## Data usage

You can track the amount of data your phone uploads and downloads.

**Find it:** Swipe up  >  **Settings** > **Network & internet** > **Mobile network** > **App data usage**

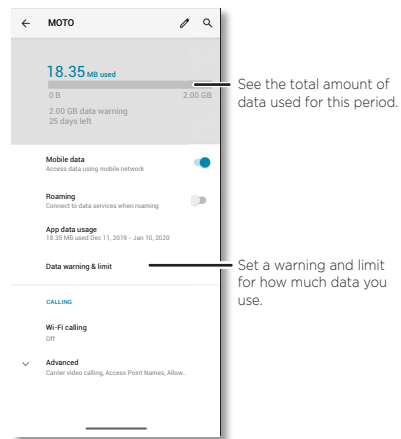

Some apps transfer data in the background when you're not viewing them—to help reduce this type of data usage, swipe up  >  **Settings** > **Network & internet** > **Data Saver**.

**Tip:** To see Wi-Fi data usage, tap swipe up  >  **Settings** > **Network & internet** > **Wi-Fi** > **Wi-Fi data usage**.

**Note:** Usage information is provided to help you manage your phone. This may not match the amounts charged by your service provider, as they're not measured in the same way.

# Troubleshoot your phone

## Restart or remove an app

If an app locks up your phone as soon as you turn it on, restart in Safe Mode: Press and hold the Power button. When you see the **Power off** option, press and hold it. Your phone restarts with **Safe mode** in the lower left. Then, try removing the app.

To exit safe mode, restart your phone.

## Restart your phone

In the unlikely event that your phone stops responding to touches and button presses, try a reboot—press and hold the Power button until the screen goes dark and your phone restarts.

## Check for software update



To manually check for updates, swipe up  >  **Settings** > **System** > **Advanced** > **System updates**.

Your phone downloads updates over your Wi-Fi connection (if available) or mobile network. We recommend that you download updates over a Wi-Fi connection. These updates can be quite large and may not be available in all countries.

**Note:** When updating your phone, make sure you have enough battery power to complete the update.

If the mobile network updates are not available in your country, update using a computer. On your computer, go to [www.motorola.com/update](http://www.motorola.com/update).

## Reset



To reset your phone to factory settings and erase all the data on your phone, swipe up  >  **Settings** > **System** > **Advanced** > **Reset options** > **Erase all data (factory reset)**.

**Warning:** All downloaded apps and user data on your phone will be deleted. Data on the cloud will not be deleted.

## Stolen phone

Your phone has Android Device Manager. You can remotely lock or reset your device to protect your device from thieves. For details, see [www.google.com/android/devicemanager](http://www.google.com/android/devicemanager).

## Find the IMEI number

You can find the IMEI number by typing \*#06# on your phone's dialpad. Or swipe up  >  **Settings** > **About phone** > **IMEI**.

**Note:** For service and support, see [Get more help](#).



# Accessibility

See, hear, speak, feel, and use. Accessibility features are there for everyone, helping to make things easier.

**Find it:** Swipe up  >  **Settings** > **Accessibility**

For more information about your phone's accessibility features, visit [www.motorola.com/accessibility](http://www.motorola.com/accessibility).

## Create a shortcut

Use a gesture to quickly activate an accessibility feature on your phone. For more information, swipe up  >  **Settings** > **Accessibility** > **Volume key shortcut**.

Tap **Shortcut service** and choose an app. When the shortcut is on, press both volume buttons for three seconds to start the app.

## Make your phone speak

### Select to speak

**Find it:** Swipe up  >  **Settings** > **Accessibility** > **Select to Speak**

Turn on, then slide two fingers up from the bottom of the screen and press . Your phone reads the screen from top to bottom.

### TalkBack

Use TalkBack to read your screen out loud—screen navigation, selections, even books.

To turn TalkBack on or off, swipe up  >  **Settings** > **Accessibility** > **TalkBack**.







- » **Tap** something on the screen to hear a description or text readout.
- » **Double-tap** anywhere on the screen to open or activate the last touched item.
- » **Swipe** using two fingers to scroll through lists or between screens.

### Text-to-speech output

To set the language, speech rate and pitch of the screen reader, swipe up  >  **Settings** > **Accessibility** > **Text-to-speech output**.

## Braille

Combine your Braille display with TalkBack for braille and speech feedback.

- 1 Download the BrailleBack™ app on Google Play (swipe up  >  **Play Store**), and install it on your phone.
- 2 Swipe up  >  **Settings** > **Accessibility** > **BrailleBack**.
- 3 Turn on your Braille display and put it in Bluetooth pairing mode.
- 4 On your phone, swipe up  >  **Settings** > **Bluetooth**, then tap the switch at the top to turn it on and scan.
- 5 Tap the name of your Braille display to pair it with the phone.









## Speak to your phone

Speak a command to turn on an accessibility feature. For example: "Hey Google, turn on TalkBack". For more on voice commands, see [Speak](#).

## Change your phone's display



### Display settings & magnification

Get a closer look.

- » **Change font size:** Increase the font size on your screen. Swipe up  >  **Settings** > **Accessibility** > **Font size**. See also [Customize sounds & appearance](#).
- » **Change display size:** Make the items on the screen larger. Swipe up  >  **Settings** > **Accessibility** > **Display size**.
- » **Pinch to zoom:** Pinch to zoom on maps, web pages, and photos—to zoom in, tap the screen with two fingers and then drag them apart. To zoom out, drag your fingers together. You can also double-tap to zoom in.
- » **Screen magnification:** Triple-tap the screen for full screen magnification, or triple-tap and hold to temporarily magnify. Swipe up  >  **Settings** > **Accessibility** > **Magnification**.
- » **Display brightness:** Swipe the status bar down, and drag the slider to set brightness level. Setting brightness to a high level decreases your phone's battery life.
- » **Browser:** Choose text size when browsing websites. Swipe up  >  **Chrome** > **Menu**  > **Settings** > **Accessibility**. Select **Force enable zoom** to allow zooming on all

web pages.



## Messages

To make text entry even easier, use features like auto-capitalization, auto-correction, and more. Swipe up  >  **Settings** > **System** > **Languages & input** > **Virtual keyboard** > **Gboard** > **Text correction**. Or speak your message. Tap  on the keyboard.

## Change your phone's sounds

### Calls

When you want to hear who's calling, assign a unique ringtone to a contact. Swipe up  >  **Contacts**, tap the contact, then tap Menu  > **Set ringtone**.

To end a call by pressing the Power button, swipe up  >  **Settings** > **Accessibility** and tap **Power button ends call**.

### Volume & vibrate

**Find it:** Swipe up  >  **Settings** > **Sound**

- » Drag the volume sliders to set volume levels for your music or videos, alarms, and ringtones/notifications.
- » To make your phone vibrate for incoming calls (even when the ringer is silent), tap **Vibrate for calls**.

**Tip:** Feel a vibration when you tap the screen. Tap **Advanced** > **Touch vibration** to turn it on/off.

## Hearing aids (U.S. only)

To help get a clear sound when using a hearing aid or cochlear implant, your phone may have been rated for use with hearing aids. If your phone's box has "Rated for Hearing Aids" printed on it, then please read the following guidance.

**Note:** Ratings are not a guarantee of compatibility (visit [www.motorola.com/hacphones](http://www.motorola.com/hacphones)). You may also want to consult your hearing health professional, who should be able to help you get the best results.

- » **Settings:** Tap  **Phone** > Menu  > **Settings** > **Accessibility** > **Hearing aids**.
- » **Call volume:** During a call, press the side volume buttons to set a call volume that

works for you.

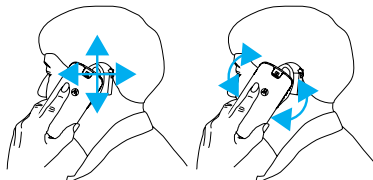

- » **Position:** During a call, hold the phone to your ear as normal, and then rotate/move it to get the best position for speaking and listening.



### TTY (U.S. only)

You can use your phone in TTY mode with standard teletype machines.

**Note:** Wi-Fi must be turned off.



Tap  **Phone** > Menu  > **Settings** > **Accessibility** > **TTY mode** and select the mode you need:

- » **TTY Full:** Type and read text on your TTY device.
- » **TTY HCO:** Type on your TTY device and listen to voice replies on your phone's speaker.
- » **TTY VCO:** Speak into your phone and read text replies on your TTY device.

**Note:** You'll need a cable/adaptor to connect your TTY device to the headset jack on your phone. Refer to your TTY device guide for mode and usage information.

# Get more help

Get answers, updates, and info:

- » **Help is here:** Swipe up  >  **Settings** > **Help** to get walk-through tutorials, how-tos, or FAQs, right on your phone.
- » **Get more:** Get software, FAQs, and more at [www.motorola.com/mymotog](http://www.motorola.com/mymotog).
- » **Join the conversation:** Find us on YouTube, Facebook™, and Twitter.

## Where is my legal, safety, & regulatory information?

In order to provide you with better access to this important information, we've made the materials accessible from the phone's settings menu and on the web. Review these materials prior to using your device. To access the materials from a connected phone, go to **Settings** > **About phone** > **Legal information**, and select a topic. To access the materials on the web, visit [www.motorola.com/device-legal](http://www.motorola.com/device-legal).

## Service & repairs

If you have questions or need assistance, we're here to help. Go to [www.motorola.com/support](http://www.motorola.com/support), where you can select from a number of customer care options.

## Copyright & trademarks

Motorola Mobility LLC  
222 W. Merchandise Mart Plaza  
Chicago, IL 60654  
[www.motorola.com](http://www.motorola.com)

Certain features, services and applications are network dependent and may not be available in all areas; additional terms, conditions and/or charges may apply. Contact your service provider for details.

All features, functionality, and other product specifications, as well as the information contained in this guide, are based upon the latest available information and believed to be accurate at the time of printing. Motorola reserves the right to change or modify any information or specifications without notice or obligation.

Note: The images in this guide are examples only.

MOTOROLA, the stylized M logo, MOTO, and the MOTO family of marks are trademarks or registered trademarks of Motorola Trademark Holdings, LLC. LENOVO is a trademark of Lenovo. Google, Android, Google Play and other related marks and logos are trademarks of Google LLC. microSD Logo is a trademark of SD-3C, LLC. Manufactured with Dolby technologies under license from Dolby Laboratories. Dolby, Dolby Audio, and the double-D symbol are trademarks of Dolby Laboratories. All other product or service names are the property of their respective owners.

© 2020 Motorola Mobility LLC. All rights reserved.

Product: **moto g stylus**

Manual Number: SSC8C78658-B